

TO TEST & RESET**TO REPLACE GLASS / INTERCHANGE BETWEEN RESETTABLE AND GLASS ELEMENT**

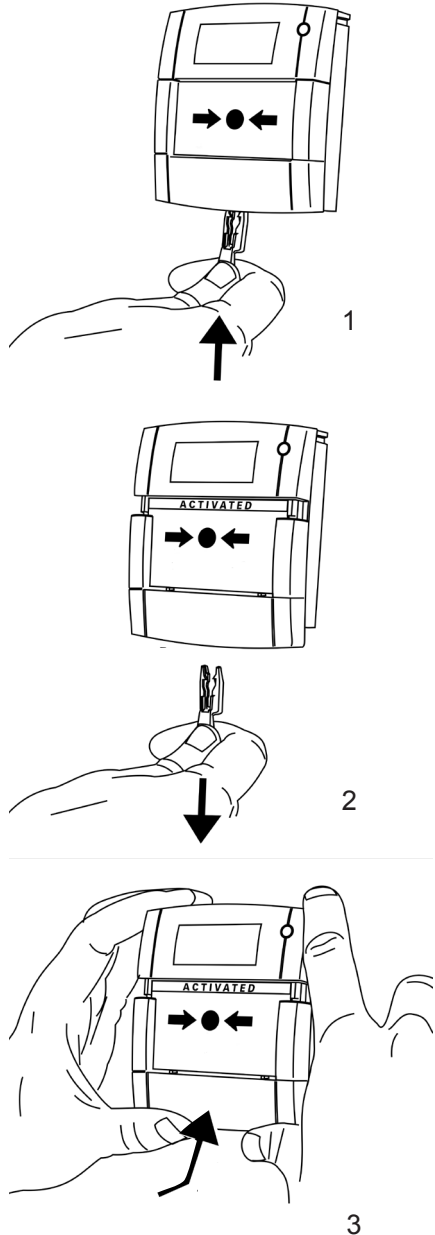

X in the MCP code (left) represents the final digits of the part number, which indicate MCP colour, component values, mounting options and element type.

eg MCP1A -R470SF = (MCP1A, Red, 470R, Surface, Flexible Element).

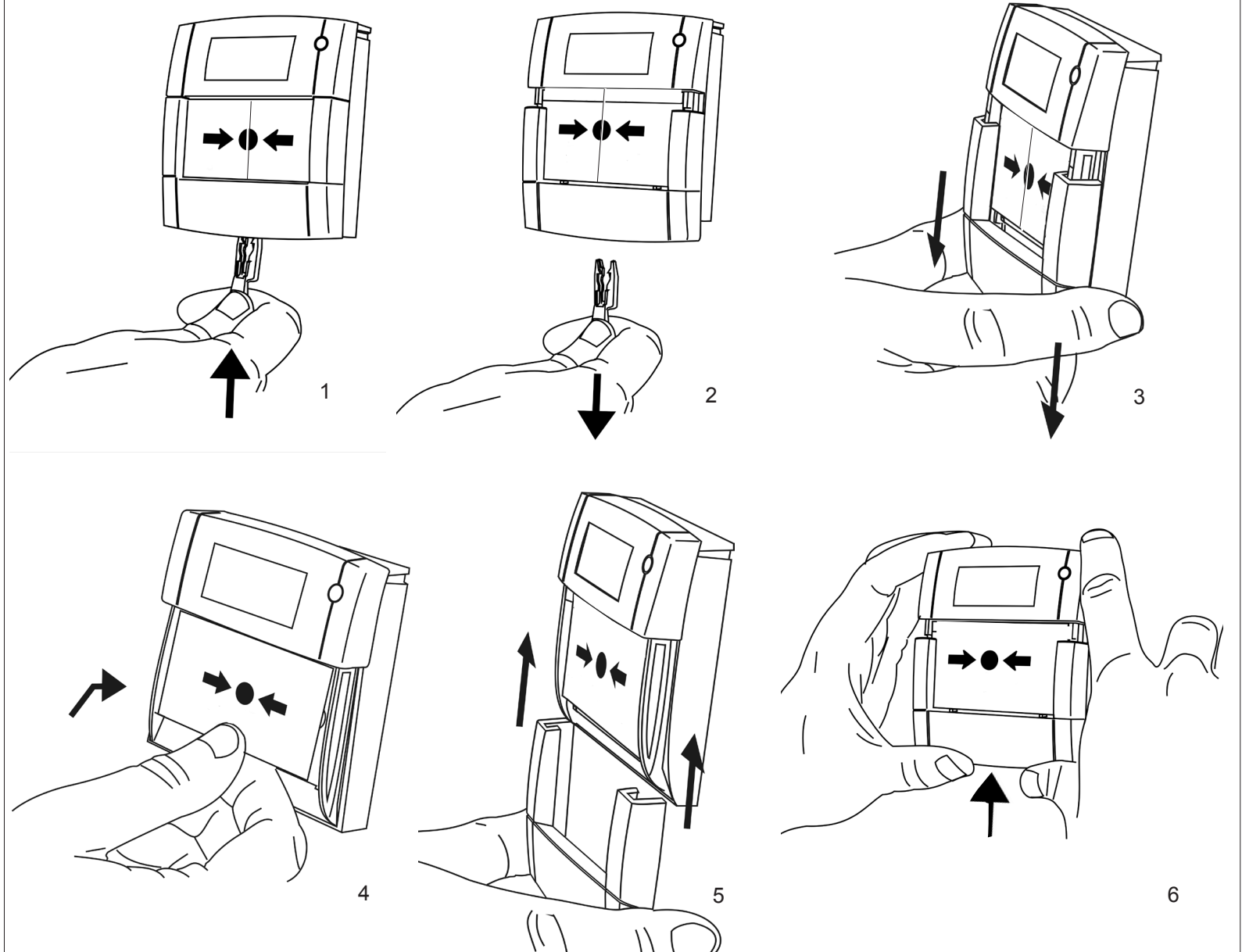
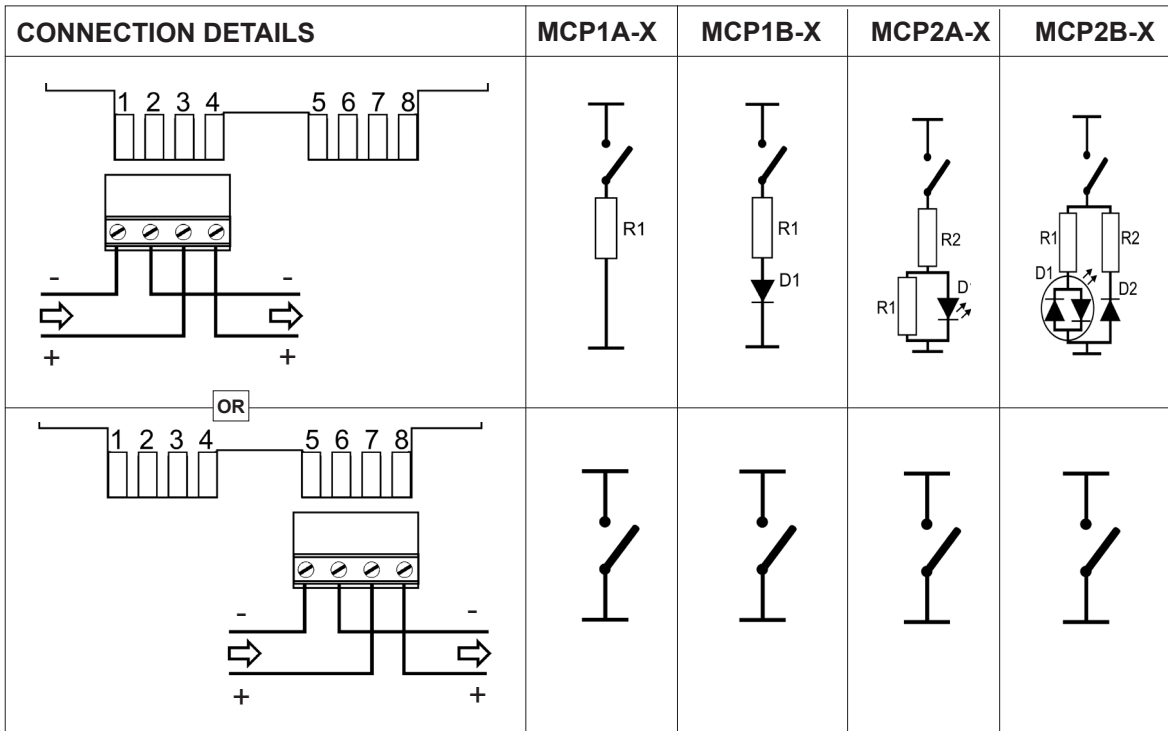
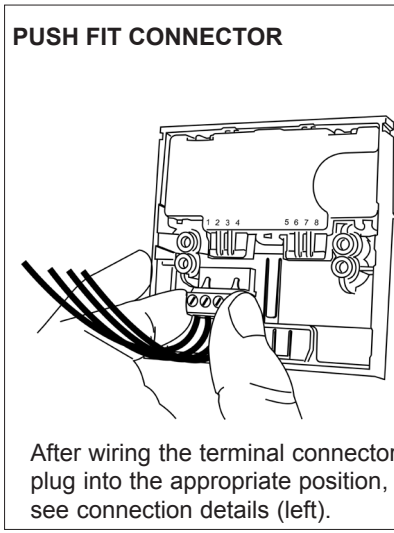
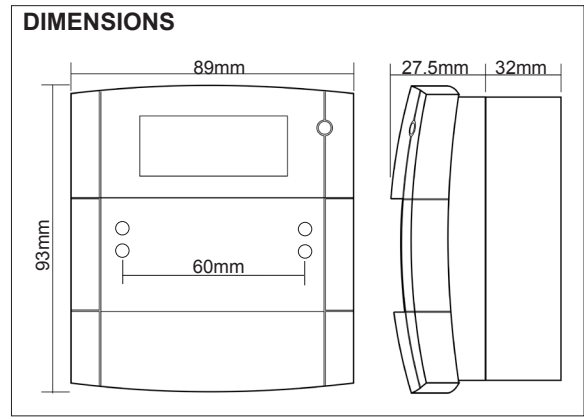

0832 16

KAC ALARM COMPANY LIMITED,
Thornhill Road, Redditch, Worcestershire, England. B98 9ND.

DOP001

EN54-11:2001/A1:2005

Fire detection and fire alarm systems - Part 11: Manual call points

MCP1, MCP2, MCP3, MCP4

Note: This table only applies to red products.

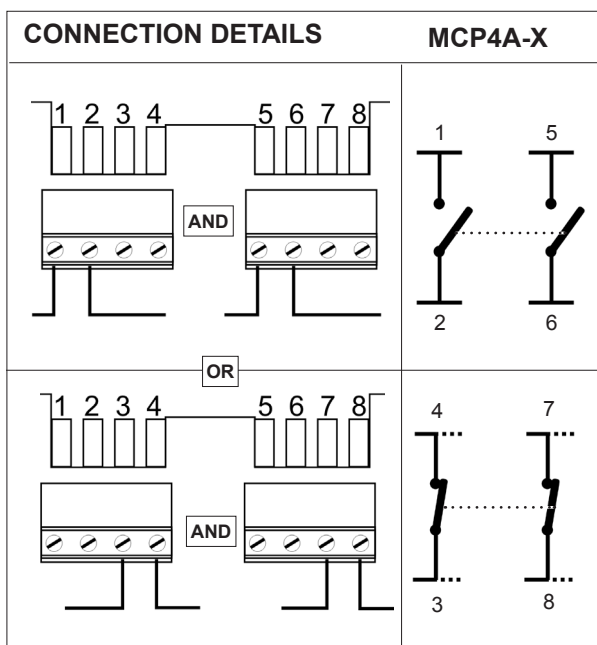
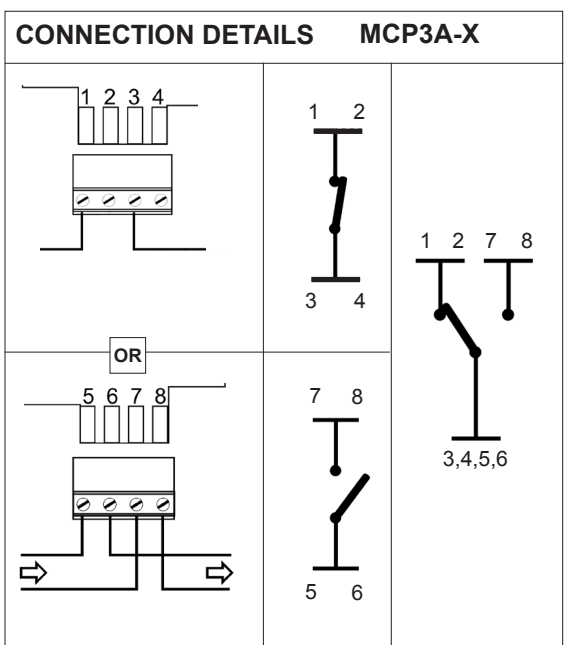

TECHNICAL DATA

	30VDC Max		Red, Ral 3001 Yellow, Ral 1006 Green, Ral 6016 White, Ral 9010 Blue, Ral 5002
	2A Max		Important Notes; - Please do not over tighten fixing screws. The use of lubricants, cleaning solvents or petroleum based products should be avoided.
	IP24D		
	110/160g		
	-10 ⁰ C to 55 ⁰ C		