

<p>2831 16</p>
<p>KAC ALARM COMPANY LIMITED, Thornhill Road, Redditch, Worcestershire, England. B98 9ND.</p> <p>DOP002</p>
<p>EN54-11:2001/A1:2005</p> <p>Fire detection and fire alarm systems - Part 11: Manual call points.</p> <p>WCP1</p> <p>Note: This table only applies to red products.</p>

Installation

The integral back box has three 20mm diameter threaded holes. Two hole stoppers are provided for use as required. The cable entry holes of the back box must not be subjected to stress by the cable or conduit. The use of sealant such as Loctite product 5331 is recommended.

Wiring

Connection to the WCP is made via the 4 way terminal connector as shown overleaf. Each terminal will accommodate a conductor of 2.5mm².

Earthing

An Earth Continuity Terminal is situated in the rear of the back box. This is designed to accommodate 2 conductors of up to 2.5mm². An earthing plate is provided for continuity of metal conduits. This must be placed behind the back box prior to fixing the box to the wall.

Important Notes; -

Please do not over tighten fixing screws.

The use of lubricants, cleaning solvents or petroleum based products should be avoided.

The O-ring should be replaced when refitting or replacing the Waterproof Cover.



INSTALLATION INSTRUCTIONS FOR THE WATERPROOF MANUAL CALL POINT MODELS WCP1B....,

Model WCP1B

This Model provides a Normally Open contact with series monitoring resistor and diode (Savwire Model), or a clean, normally open contact by means of the alternative positioning of the terminal connector.

General

These Call Points are suitable for IP67 environments.

Wall Mounting of Back Box

Mount the back box to a suitably flat surface using the three fixing holes and the screws provided in the installation pack. The cable entry holes should be in the vertical plane. The back box can be mounted with either the single or the double entry holes at the top.

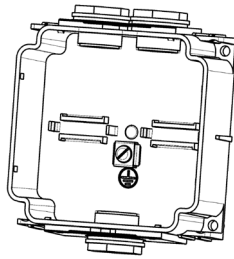

Fitting the WCP Cover to the back box

Plug the 4 way terminal connector onto the appropriate position as shown. Ensure that the O-ring is correctly seated in the channel on the rear of the cover. Place the cover squarely over the back box and carefully push the cover until the locating clips have engaged. Do not use excessive force. It is recommended that the 4 cover fixing screws are used to lock the cover into place.

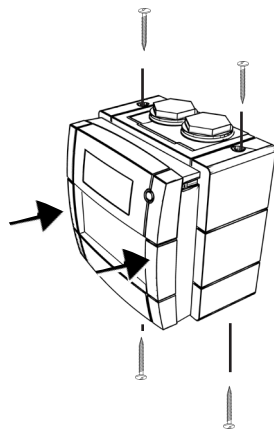
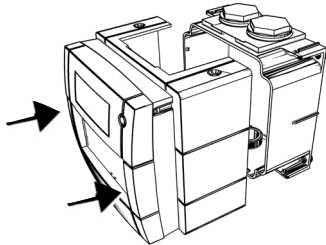

WCP Cover removal

To remove the cover, undo and remove the 4 Cover fixing screws. Place the edge of a large flat bladed screwdriver into the slot between the Cover and back box as shown in below and gently twist until the latches are disengaged. Pull cover away from backbox.

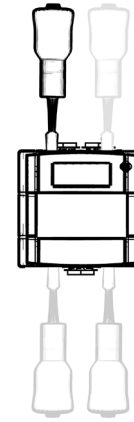
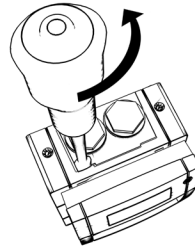

DIMENSIONS

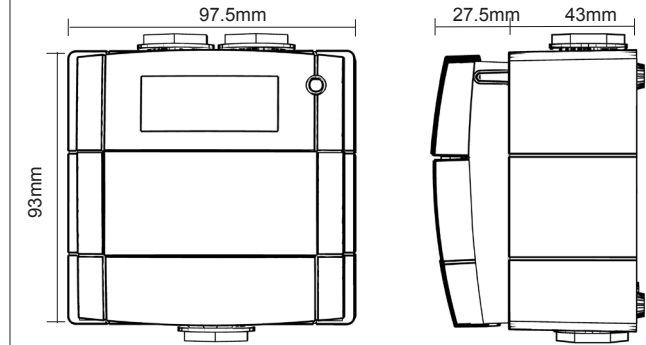

CONNECTION DETAILS

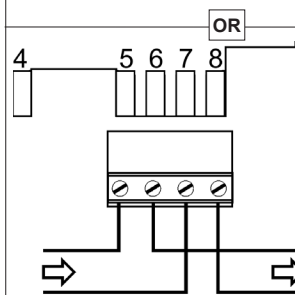
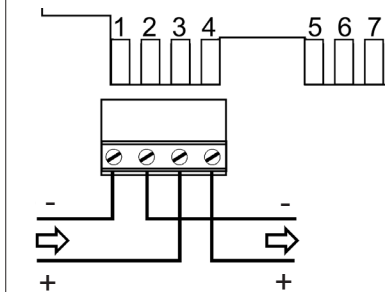

WCP1B-X

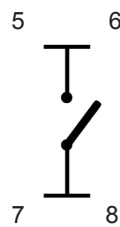
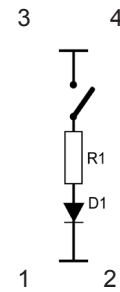

X in the WCP code (above) represents the final digits of the part number, which indicate MCP colour, component values, mounting options and element type. eg WCP1A -R470SF = (WCP1A, Red, 470R, Surface, Flexible Element).

PUSH FIT CONNECTOR

After wiring the terminal connector, plug into the appropriate position, see connection details (left).

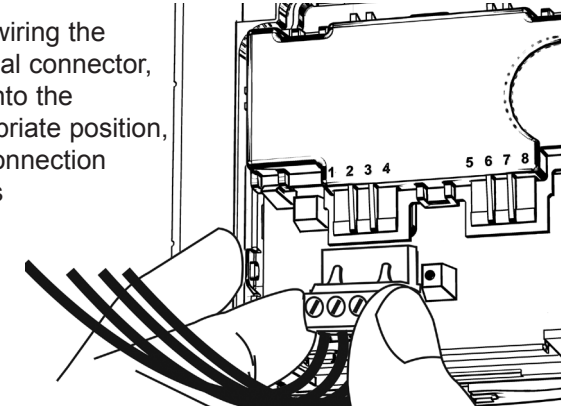

TECHNICAL DATA



30VDC Max



-25°C to 70°C



2A Max



Red, Ral 3001
Yellow, Ral 1006
Green, Ral 6024
White, Ral 9010
Blue, Ral 5005



IP 67*



350g

* - IP67 is not a requirement of EN54-11.